

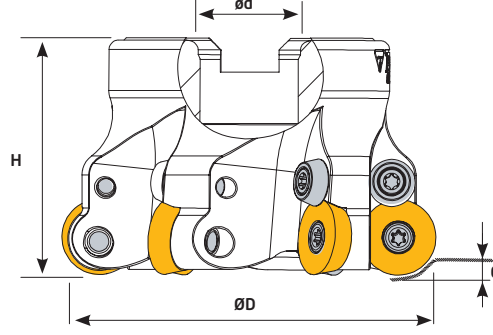

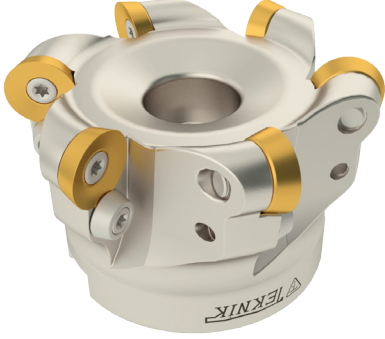

RDMT 1604



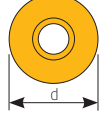

Ölçüler (mm) Dimensions(mm) Abmessungen (mm)		RDMT 1604	
d	s		
16	4,76		

Sipariş Kodu Order Code Best.-Nr.	Stok/Stock/Lager	Ürün Kodu Product Code Produkt-Code	Ölçüler (mm) Dimensions(mm) Abmessungen (mm)					Kullanılan Uç Insert WSP	Baskı Pulu Flat Washer U-Scheibe	Baskı Cıvatası Locking Screw Verriegelungs Schraube	Sıkma Cıvatası Clamp Screw Torx-Schraube	Anahtar Torx Key Torx-Schlüssel
			ØD	ød	Z	H						
T270	●	D050 d22 Z04 RDMT 16	50	22	4	50	0,350	RDMT1604 ISO	BSP010	TC074 M4x10	TC080 M4,5x11	T20
T271	●	D052 d22 Z04 RDMT 16	52	22	4	50	0,350					
T273	●	D063 d22 Z05 RDMT 16	63	22	5	45	0,512					
T272	●	D066 d27 Z05 RDMT 16	66	27	5	50	0,495					
T274	●	D080 d27 Z06 RDMT 16	80	27	6	50	0,890					
T275	●	D100 d32 Z07 RDMT 16	100	32	7	52	1,370					

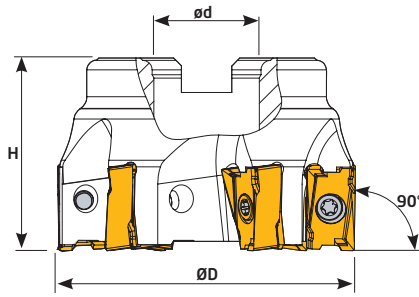
90° LNGU 15T6

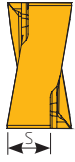
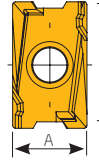

Ölçüler (mm) Dimensions(mm) Abmessungen (mm)			LNGU 15T6	
L	S	A		
17	9,69	10		

Sipariş Kodu Order Code Best.-Nr.	Stok/Stock/Lager	Ürün Kodu Product Code Produkt-Code	Ölçüler (mm) Dimensions(mm) Abmessungen (mm)					Kullanılan Uç Insert WSP	Sıkma Cıvatası Clamp Screw Torx-Schraube	Anahtar Torx Key Torx-Schlüssel
			ØD	ød	Z	H				
T956	●	D050 d22 Z05 LNGU 15	50	22	5	40	0,305	LNGU 15T6 KNNMTL	TC075 M4x11	T15
T958	●	D063 d22 Z06 LNGU 15	63	22	6	40	0,541			
T960	●	D080 d27 Z07 LNGU 15	80	27	7	50	1,133			
T961	○	D100 d32 Z08 LNGU 15	100	32	8	50	1,933			

KNNMTL ucuna uygundur. / Compatible with KNNMTL insert. / Kompatible für KNNMTL WP